

LM4892 Boomer® Audio Power Amplifier Series

1 Watt Audio Power Amplifier with Headphone Sense

General Description

The LM4892 is an audio power amplifier primarily designed for demanding applications in mobile phones and other portable communication device applications. It is capable of delivering 1 watt of continuous average power to an 8Ω BTL load with less than 1% distortion (THD+N) from a 5V_{DC} power supply. Switching between bridged speaker mode and headphone (single-ended) mode is accomplished using the headphone sense pin.

Boomer audio power amplifiers are designed specifically to provide high quality output power with a minimal amount of external components. The LM4892 does not require output coupling capacitors or bootstrap capacitors, and therefore is ideally suited for mobile phone and other low voltage applications where minimal power consumption is a primary requirement.

The LM4892 features a low-power consumption shutdown mode, which is achieved by driving the shutdown pin with logic low. Additionally, the LM4892 features an internal thermal shutdown protection mechanism.

The LM4892 contains advanced pop & click circuitry which eliminates noise which would otherwise occur during turn-on and turn-off transitions.

The LM4892 is unity-gain stable and can be configured by external gain-setting resistors.

Key Specifications

■ PSRR at 217Hz, V _{DD} = 5V, 8Ω Load	62dB (typ)
■ Power Output at 5.0V & 1% THD	1.0W (typ)
■ Power Output at 3.3V & 1% THD	400mW (typ)
■ Shutdown Current	0.1μA (typ)

Features

- Available in space-saving packages: LLP, micro SMD, MSOP, and SOIC
- Ultra low current shutdown mode
- BTL output can drive capacitive loads up to 500pF
- Improved pop & click circuitry eliminates noise during turn-on and turn-off transitions
- 2.2 - 5.5V operation
- No output coupling capacitors, snubber networks or bootstrap capacitors required
- Thermal shutdown protection
- Unity-gain stable
- External gain configuration capability
- Headphone amplifier mode

Applications

- Mobile Phones
- PDAs
- Portable electronic devices

Typical Application

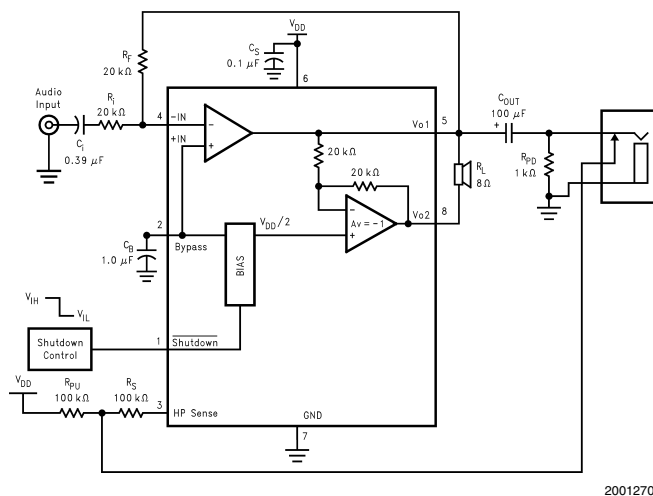
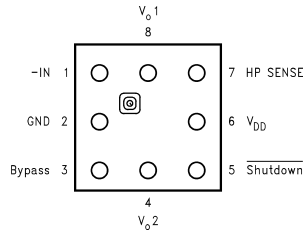

FIGURE 1. Typical Audio Amplifier Application Circuit (Pin #'s apply to M & MM packages)

Connection Diagrams

8 Bump micro SMD



20012723

Top View

Order Number LM4892IBP, LM4892IBPX
See NS Package Number BPA08DDB

Mini Small Outline (MSOP) Package

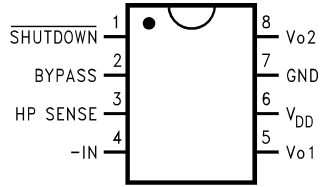

20012736

Top View

Order Number LM4892MM
See NS Package Number MUA08A

SO Marking

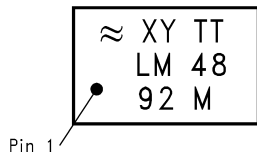

20012772

Top View

XY - Date Code
TT - Die Traceability
Bottom 2 lines - Part Number

LLP Package

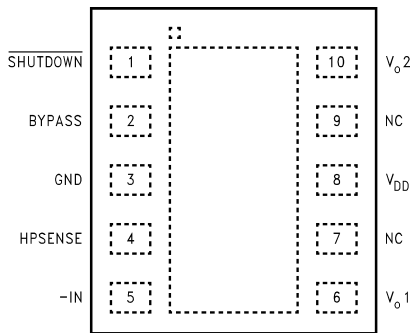

20012789

Top View

Order Number LM4892LD
See NS Package Number LDA10B

Small Outline (SO) Package

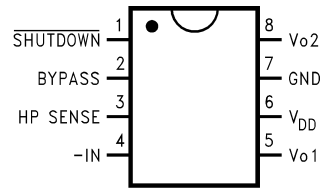

20012735

Top View

Order Number LM4892M
See NS Package Number M08A

micro SMD Marking

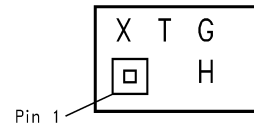

20012770

Top View

X - Date Code
T - Die Traceability
G - Boomer Family
H - LM4892IBP

MSOP Marking

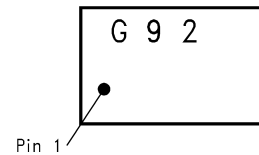

20012771

Top View

G - Boomer Family
92 - LM4892MM

Absolute Maximum Ratings (Note 2)

If Military/Aerospace specified devices are required, please contact the National Semiconductor Sales Office/Distributors for availability and specifications.

Supply Voltage	6.0V
Storage Temperature	-65°C to +150°C
Input Voltage	-0.3V to $V_{DD} + 0.3V$
Power Dissipation (Note 3)	Internally Limited
ESD Susceptibility (Note 4)	2500V
ESD Susceptibility (Note 5)	250V
Junction Temperature	150°C
Thermal Resistance	
θ_{JC} (SOP)	35°C/W
θ_{JA} (SOP)	150°C/W
θ_{JA} (micro SMD)	220°C/W

θ_{JC} (MSOP)	56°C/W
θ_{JA} (MSOP)	190°C/W
θ_{JA} (LLP)	220°C/W (Note 9)

Soldering Information

See AN-1112 'microSMD Wafers Level Chip Scale Package'.

See AN-1187 'Leadless Leadframe Package (LLP)'.

Operating Ratings**Temperature Range**

$$T_{MIN} \leq T_A \leq T_{MAX} \quad -40^\circ\text{C} \leq T_A \leq 85^\circ\text{C}$$

Supply Voltage

$$2.2V \leq V_{DD} \leq 5.5V$$

Electrical Characteristics $V_{DD} = 5V$ (Notes 1, 2)

The following specifications apply for $V_{DD} = 5V$, $A_V = 2$, and 8Ω load unless otherwise specified. Limits apply for $T_A = 25^\circ\text{C}$.

Symbol	Parameter	Conditions	LM4892		Units (Limits)
			Typical	Limit	
			(Note 6)	(Note 7)	
I_{DD}	Quiescent Power Supply Current	$V_{IN} = 0V$, $I_o = 0A$, HP sense = 0V	4	10	mA (max)
		$V_{IN} = 0V$, $I_o = 0A$, HP sense = 5V	2.5		mA (max)
I_{SD}	Shutdown Current	$V_{shutdown} = GND$ (Note 8)	0.1		μA (max)
P_o	Output Power	THD = 2% (max), $f = 1\text{kHz}$, $R_L = 8\Omega$, HP Sense < 0.8V	1		W
		THD = 1% (max), $f = 1\text{kHz}$, $R_L = 32\Omega$, HP Sense > 4V	90		mW
V_{IH}	HP Sense high input voltage			4	V (min)
V_{IL}	HP Sense low input voltage			0.8	V (max)
THD+N	Total Harmonic Distortion+Noise	$P_o = 0.4 W_{rms}$; $f = 1\text{kHz}$ 10Hz \leq BW $\leq 80\text{kHz}$	0.1		%
PSSR	Power Supply Rejection Ratio	$V_{ripple} = 200\text{mV}$ sine p-p	62 ($f =$ 217Hz) 66 ($f =$ 1kHz)		dB

Electrical Characteristics $V_{DD} = 3.3V$ (Notes 1, 2)

The following specifications apply for $V_{DD} = 3.3V$, $A_V = 2$, and 8Ω load unless otherwise specified. Limits apply for $T_A = 25^\circ\text{C}$.

Symbol	Parameter	Conditions	LM4892		Units (Limits)
			Typical	Limit	
			(Note 6)	(Note 7)	
I_{DD}	Quiescent Power Supply Current	$V_{IN} = 0V$, $I_o = 0A$, HP sense = 0V	3.5		mA (max)
		$V_{IN} = 0V$, $I_o = 0A$, HP sense = 3.3V	2.0		mA (max)
I_{SD}	Shutdown Current	$V_{shutdown} = GND$ (Note 8)	0.1		μA (max)
P_o	Output Power	THD = 1% (max), $f = 1\text{kHz}$, $R_L = 8\Omega$, HP Sense < 0.8V	0.4		W
		THD = 1% (max), $f = 1\text{kHz}$, $R_L = 32\Omega$, HP Sense > 3V	35		mW
V_{IH}	HP Sense high input voltage			2.6	V (min)
V_{IL}	HP Sense low input voltage			0.8	V (max)
THD+N	Total Harmonic Distortion+Noise	$P_o = 0.15 W_{rms}$; $f = 1\text{kHz}$ 10Hz \leq BW $\leq 80\text{kHz}$	0.1		%

Electrical Characteristics $V_{DD} = 3.3V$ (Notes 1, 2)

The following specifications apply for $V_{DD} = 3.3V$, $A_V = 2$, and 8Ω load unless otherwise specified. Limits apply for $T_A = 25^\circ C$. (Continued)

Symbol	Parameter	Conditions	LM4892		Units (Limits)
			Typical	Limit	
			(Note 6)	(Note 7)	
PSSR	Power Supply Rejection Ratio	$V_{ripple} = 200mV$ sine p-p	60(f = 217Hz) 62 (f = 1kHz)		dB

Electrical Characteristics $V_{DD} = 2.6V$ (Notes 1, 2)

The following specifications apply for $V_{DD} = 2.6V$, $A_V = 2$, and 8Ω load unless otherwise specified. Limits apply for $T_A = 25^\circ C$.

Symbol	Parameter	Conditions	LM4892		Units (Limits)
			Typical	Limit	
			(Note 6)	(Note 7)	
I_{DD}	Quiescent Power Supply Current	$V_{IN} = 0V$, $I_o = 0A$, HP sense = 0V	2.6		mA (max)
		$V_{IN} = 0V$, $I_o = 0A$, HP sense = 2.6V	1.5		mA (max)
I_{SD}	Shutdown Current	$V_{shutdown} = GND$ (Note 8)	0.1		μA (max)
P_o	Output Power	THD = 1% (max), f = 1kHz, $R_L = 8\Omega$, HP Sense < 0.8V	0.25		W
		THD = 1% (max), f = 1kHz, $R_L = 4\Omega$, HP Sense < 0.8V	0.28		W
		THD = 1% (max), f = 1kHz, $R_L = 32\Omega$, HP Sense > 2.5V	20		mW
V_{IH}	HP Sense high input voltage			2.0	V (min)
V_{IL}	HP Sense low input voltage			0.8	V (max)
THD+N	Total Harmonic Distortion+Noise	$P_o = 0.1 W_{rms}$; f = 1kHz 10Hz \leq BW \leq 80kHz	0.1		%
PSSR	Power Supply Rejection Ratio	$V_{ripple} = 200mV$ sine p-p	44(f = 217Hz) 44 (f = 1kHz)		dB

Note 1: All voltages are measured with respect to the ground pin, unless otherwise specified.

Note 2: *Absolute Maximum Ratings* indicate limits beyond which damage to the device may occur. *Operating Ratings* indicate conditions for which the device is functional, but do not guarantee specific performance limits. *Electrical Characteristics* state DC and AC electrical specifications under particular test conditions which guarantee specific performance limits. This assumes that the device is within the Operating Ratings. Specifications are not guaranteed for parameters where no limit is given, however, the typical value is a good indication of device performance.

Note 3: The maximum power dissipation must be derated at elevated temperatures and is dictated by T_{JMAX} , θ_{JA} , and the ambient temperature T_A . The maximum allowable power dissipation is $P_{DMAX} = (T_{JMAX} - T_A) / \theta_{JA}$ or the number given in Absolute Maximum Ratings, whichever is lower. For the LM4892, see power derating currents for additional information.

Note 4: Human body model, 100pF discharged through a 1.5k Ω resistor.

Note 5: Machine Model, 220pF–240pF discharged through all pins.

Note 6: Typicals are measured at 25°C and represent the parametric norm.

Note 7: Datasheet min/max specification limits are guaranteed by design, test, or statistical analysis.

Note 8: For micro SMD only, shutdown current is measured in a Normal Room Environment. Exposure to direct sunlight will increase I_{SD} by a maximum of 2 μA .

Note 9: The Exposed-DAP of the LDA10B package should be electrically connected to GND or an electrically isolated copper area. The LM4892LD demo board (views featured in the **Application Information** section) has the Exposed-DAP connected to GND with a PCB area of 353mils x 86.7mils (8.97mm x 2.20mm) on the copper top layer and 714.7mils x 368mils (18.15mm x 9.35mm) on the copper bottom layer.

External Components Description

(Figure 1)

Components		Functional Description
1.	R_i	Inverting input resistance which sets the closed-loop gain in conjunction with R_f . This resistor also forms a high pass filter with C_i at $f_c = 1/(2\pi R_i C_i)$.
2.	C_i	Input coupling capacitor which blocks the DC voltage at the amplifiers input terminals. Also creates a highpass filter with R_i at $f_c = 1/(2\pi R_i C_i)$. Refer to the section, Proper Selection of External Components , for an explanation of how to determine the value of C_i .
3.	R_f	Feedback resistance which sets the closed-loop gain in conjunction with R_i .

External Components Description (Figure 1) (Continued)

Components		Functional Description
4.	C_S	Supply bypass capacitor which provides power supply filtering. Refer to the Power Supply Bypassing section for information concerning proper placement and selection of the supply bypass capacitor.
5.	C_B	Bypass pin capacitor which provides half-supply filtering. Refer to the section, Proper Selection of External Components , for information concerning proper placement and selection of C_B .
6.	C_{OUT}	This output coupling capacitor blocks DC voltage while coupling the AC audio signal to the headphone speaker. Combined with R_L , the headphone impedance, it creates a high pass filter at $f_c = 1/(2\pi R_L C_{OUT})$. Refer to the section, Proper Selection of External Components for an explanation of how to determine the value of C_{OUT} .
7.	R_{PU}	This is the pull up resistor to activate headphone operation when a headphone plug is plugged into the headphone jack.
8.	R_S	This is the current limiting resistor for the headphone input pin.
9.	R_{PD}	This is the pull down resistor to de-activate headphone operation when no headphone is plugged into the headphone jack.

Typical Performance Characteristics

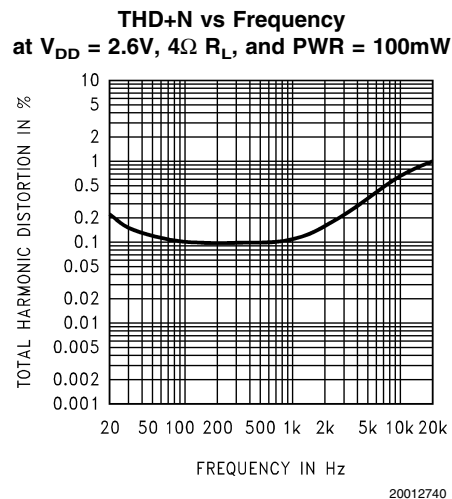
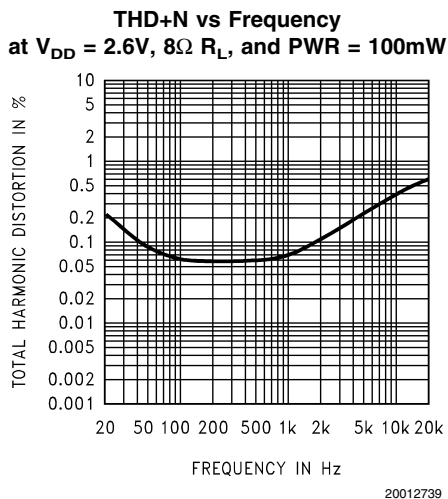
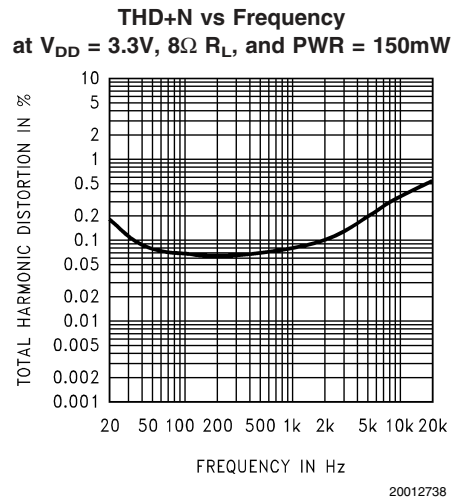
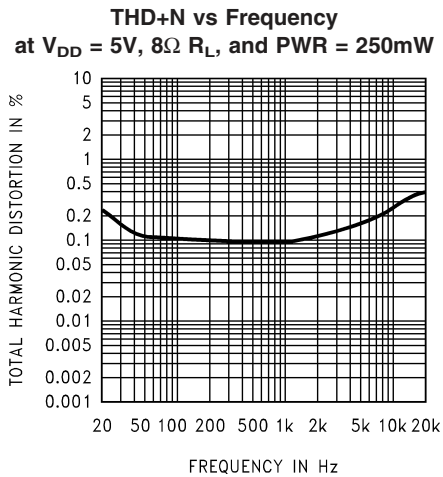

Typical Performance Characteristics (Continued)

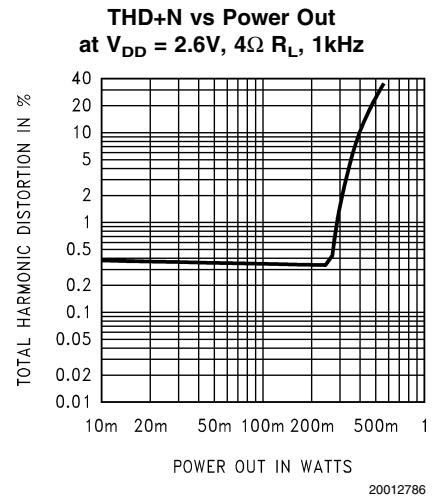
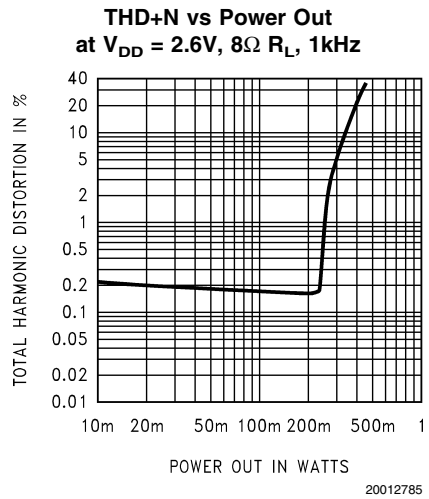
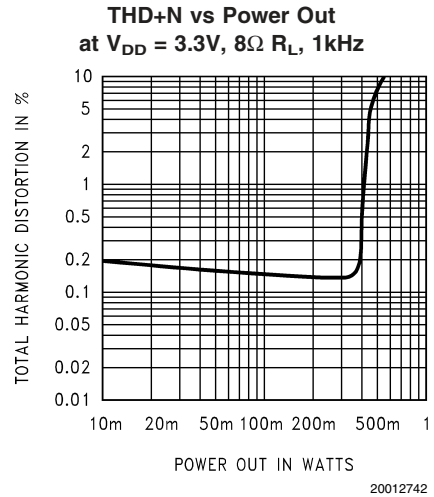
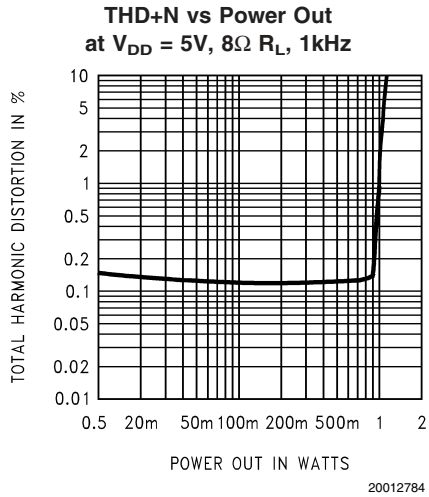

Power Supply Rejection Ratio (PSRR) vs Frequency
at $V_{DD} = 5V$, $8\Omega R_L$

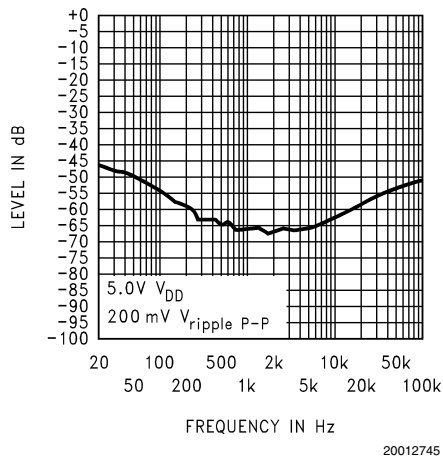

Input terminated with $10\Omega R$

Power Supply Rejection Ratio (PSRR) vs Frequency
at $V_{DD} = 5V$, $8\Omega R_L$

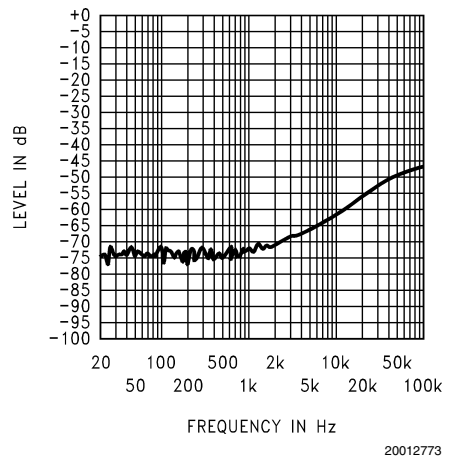

Input Floating

Typical Performance Characteristics (Continued)

Power Supply Rejection Ratio (PSRR) vs Frequency
at $V_{DD} = 2.6V$, $8\Omega R_L$

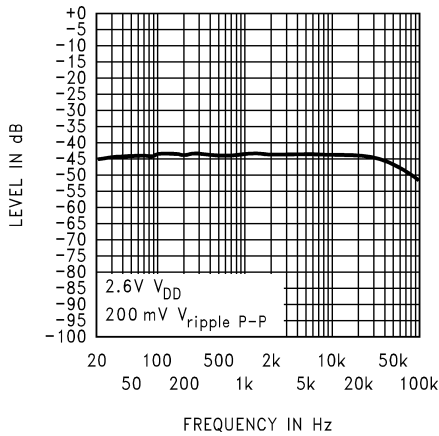

Input terminated with $10\Omega R$

Power Supply Rejection Ratio (PSRR) vs Frequency
at $V_{DD} = 3.3V$, $8\Omega R_L$

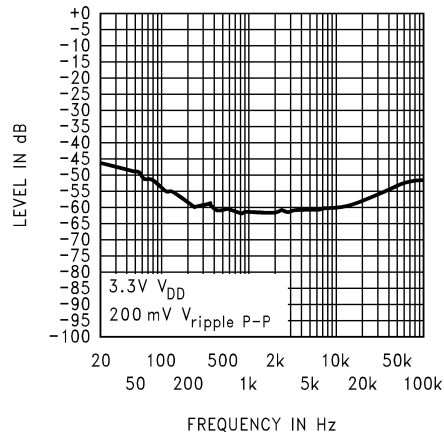

Input terminated with $10\Omega R$

Power Dissipation vs Output Power
 $V_{DD} = 3.3V$

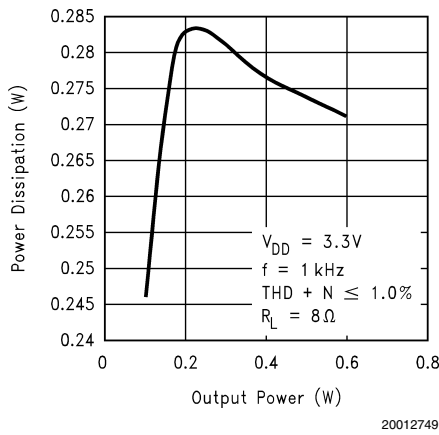

Power Dissipation vs Output Power
 $V_{DD} = 5V$

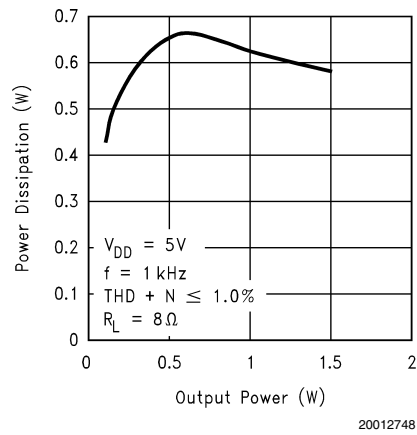

Output Power vs Load Resistance

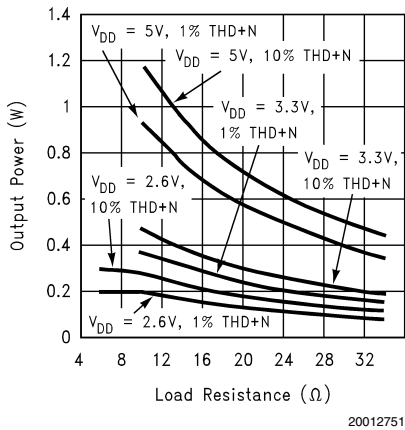

Power Dissipation vs Output Power
 $V_{DD} = 2.6V$

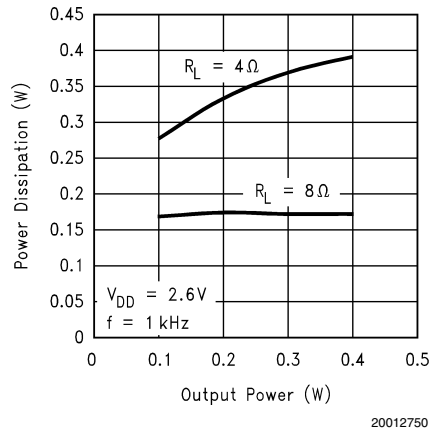

Typical Performance Characteristics (Continued)

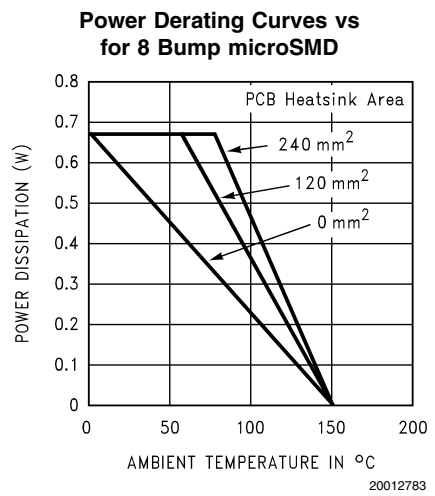
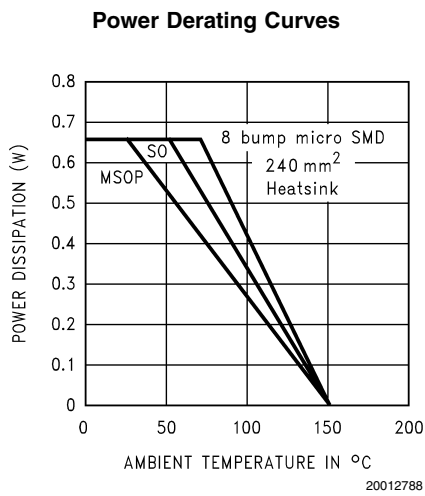
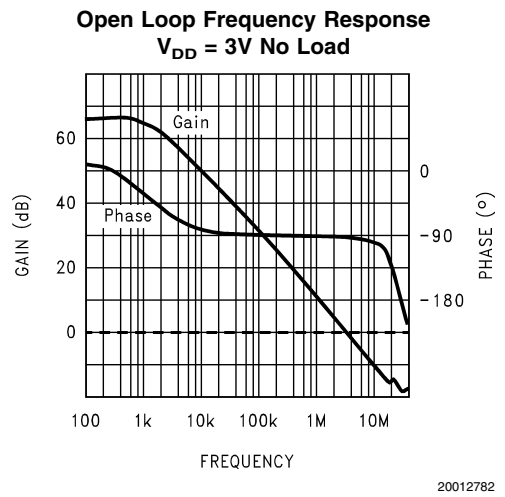
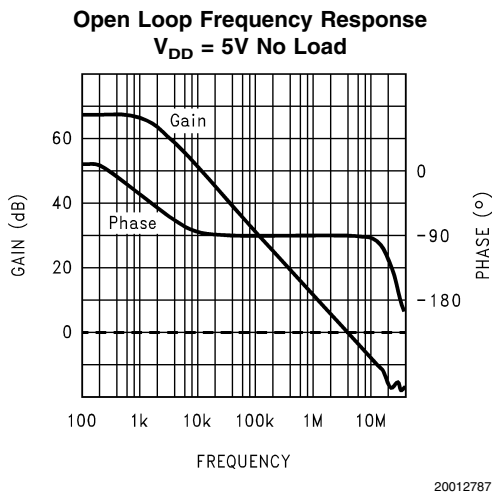
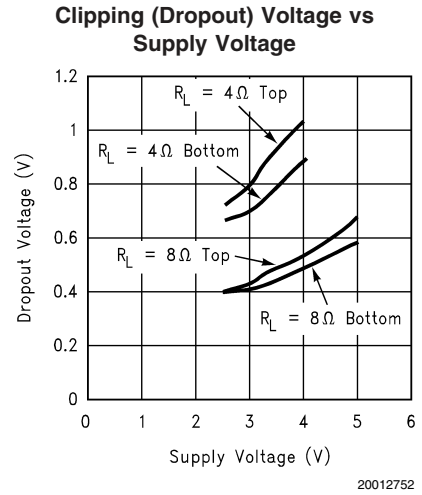
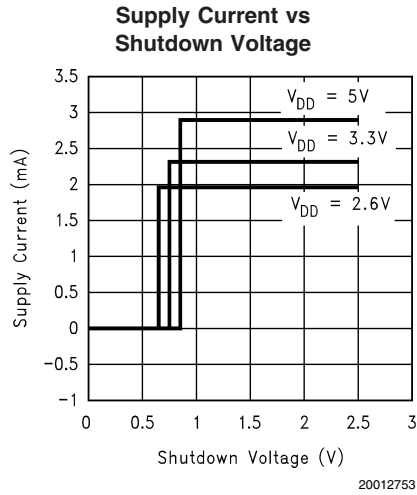

Typical Performance Characteristics (Continued)

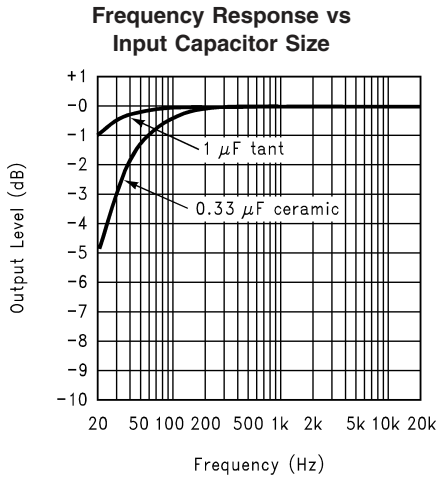

20012754

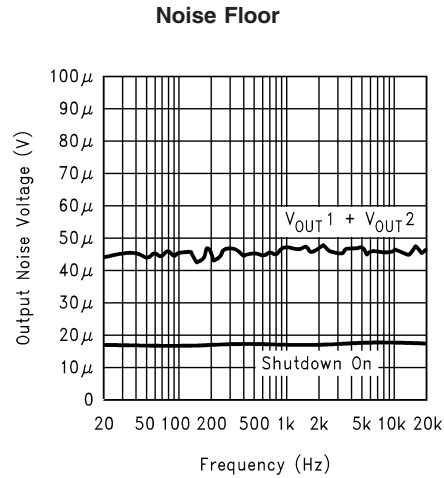

20012756

THD+N vs Frequency
at $V_{DD} = 5V$, $R_L = 32\Omega$, $PWR = 70mW$, Headphone mode

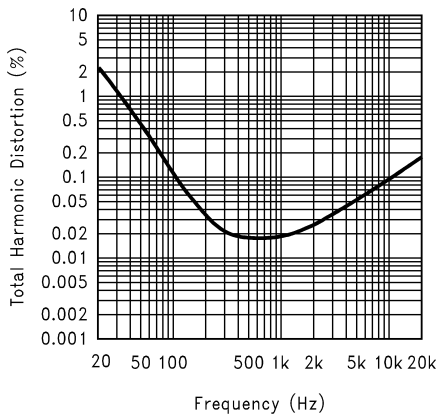

20012776

THD+N vs Power Out
at $V_{DD} = 5V$, $R_L = 32\Omega$, 1kHz, Headphone mode

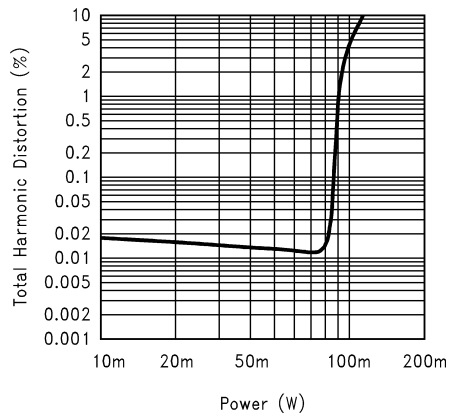

20012777

Output Power vs Supply Voltage
 $R_L = 8\Omega$

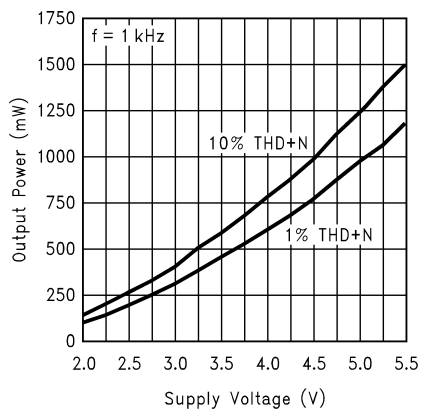

20012778

Output Power vs Supply Voltage
 $R_L = 16\Omega$

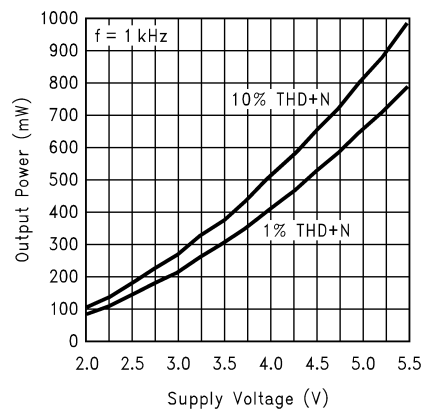

20012779

Typical Performance Characteristics (Continued)

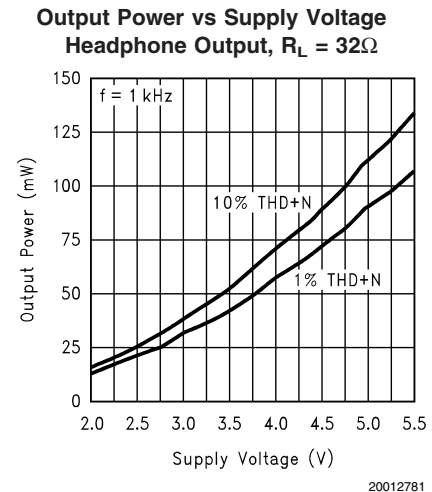
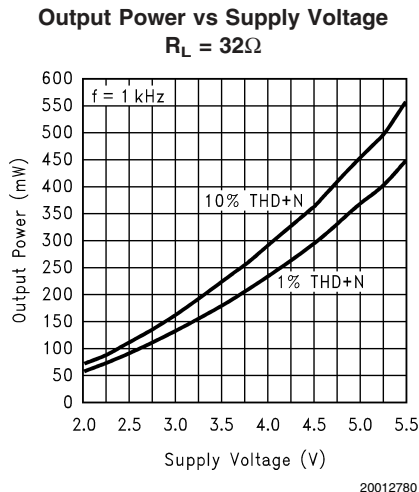

Application Information

BRIDGE CONFIGURATION EXPLANATION

As shown in *Figure 1*, the LM4892 has two operational amplifiers internally, allowing for a few different amplifier configurations. The first amplifier's gain is externally configurable, while the second amplifier is internally fixed in a unity-gain, inverting configuration. The closed-loop gain of the first amplifier is set by selecting the ratio of R_f to R_i , while the second amplifier's gain is fixed by the two internal $20k\Omega$ resistors. *Figure 1* shows that the output of amplifier one serves as the input to amplifier two which results in both amplifiers producing signals identical in magnitude, but out of phase by 180° . Consequently, the differential gain for the IC is

$$A_{VD} = 2 * (R_f/R_i)$$

By driving the load differentially through outputs Vo1 and Vo2, an amplifier configuration commonly referred to as "bridged mode" is established. Bridged mode operation is different from the classical single-ended amplifier configuration where one side of the load is connected to ground.

A bridge amplifier design has a few distinct advantages over the single-ended configuration, as it provides differential drive to the load, thus doubling output swing for a specified supply voltage. Four times the output power is possible as compared to a single-ended amplifier under the same conditions. This increase in attainable output power assumes that the amplifier is not current limited or clipped. In order to choose an amplifier's closed-loop gain without causing excessive clipping, please refer to the **Audio Power Amplifier Design** section.

A bridge configuration, such as the one used in LM4892, also creates a second advantage over single-ended amplifiers. Since the differential outputs, Vo1 and Vo2, are biased at half-supply, no net DC voltage exists across the load. This eliminates the need for an output coupling capacitor which is required in a single supply, single-ended amplifier configuration. Without an output coupling capacitor, the half-supply bias across the load would result in both increased internal IC power dissipation and also possible loudspeaker damage.

POWER DISSIPATION

Power dissipation is a major concern when designing a successful amplifier, whether the amplifier is bridged or single-ended. A direct consequence of the increased power delivered to the load by a bridge amplifier is an increase in internal power dissipation. Since the LM4892 has two operational amplifiers in one package, the maximum internal power dissipation is 4 times that of a single-ended amplifier. The maximum power dissipation for a given application can be derived from the power dissipation graphs or from Equation 1.

$$P_{DMAX} = 4 * (V_{DD})^2 / (2\pi^2 R_L) \quad (1)$$

It is critical that the maximum junction temperature T_{JMAX} of 150°C is not exceeded. T_{JMAX} can be determined from the power derating curves by using P_{DMAX} and the PC board foil area. By adding additional copper foil, the thermal resistance of the application can be reduced from a free air value of 150°C/W , resulting in higher P_{DMAX} . Additional copper foil can be added to any of the leads connected to the LM4892. It is especially effective when connected to V_{DD} , GND, and the output pins. Refer to the application information on the LM4892 reference design board for an example of good heat sinking. If T_{JMAX} still exceeds 150°C , then additional changes must be made. These changes can include reduced supply voltage, higher load impedance, or reduced ambient temperature. Internal power dissipation is a function of output power. Refer to the **Typical Performance Characteristics** curves for power dissipation information for different output powers and output loading.

POWER SUPPLY BYPASSING

As with any amplifier, proper supply bypassing is critical for low noise performance and high power supply rejection. The capacitor location on both the bypass and power supply pins should be as close to the device as possible. Typical applications employ a $5V$ regulator with $10\mu\text{F}$ tantalum or electrolytic capacitor and a ceramic bypass capacitor which aid in supply stability. This does not eliminate the need for bypassing the supply nodes of the LM4892. The selection of a bypass capacitor, especially C_B , is dependent upon PSRR

Application Information (Continued)

requirements, click and pop performance (as explained in the section, **Proper Selection of External Components**), system cost, and size constraints.

SHUTDOWN FUNCTION

In order to reduce power consumption while not in use, the LM4892 contains a shutdown pin to externally turn off the amplifier's bias circuitry. This shutdown feature turns the amplifier off when a logic low is placed on the shutdown pin. By switching the shutdown pin to ground, the LM4892 supply current draw will be minimized in idle mode. While the device will be disabled with shutdown pin voltages less than $0.5V_{DC}$, the idle current may be greater than the typical value of $0.1\mu A$. (Idle current is measured with the shutdown pin grounded).

In many applications, a microcontroller or microprocessor output is used to control the shutdown circuitry to provide a quick, smooth transition into shutdown. Another solution is to use a single-pole, single-throw switch in conjunction with an external pull-up resistor. When the switch is closed, the shutdown pin is connected to ground and disables the amplifier. If the switch is open, then the external pull-up resistor will enable the LM4892. This scheme guarantees that the shutdown pin will not float thus preventing unwanted state changes.

Table 1. Logic Level Truth Table for Shutdown and HP Sense Operation

Shutdown	HP Sense Pin	Operational Mode
Logic High	Logic Low	Bridged Amplifier
Logic High	Logic High	Single-Ended Amplifier
Logic Low	Logic Low	Micro-Power Shutdown
Logic Low	Logic High	Micro-Power Shutdown

HP SENSE FUNCTION

Applying a voltage between 4V and V_{CC} to the LM4892's HP-Sense headphone control pin turns off Amp2 and mutes a bridged-connected load. Quiescent current consumption is reduced when the IC is in the single-ended mode.

Figure 2 shows the implementation of the LM4892's headphone control function. With no headphones connected to the headphone jack, the R_4 - R_6 voltage divider sets the voltage applied to the HP-Sense pin (pin3) at approximately 50mV. This 50mV enables the LM4892 and places it in bridged mode operation.

While the LM4892 operates in bridged mode, the DC potential across the load is essentially 0V. Since the HP-Sense threshold is set at 4V, even in an ideal situation, the output swing can not cause a false single-ended trigger. Connecting headphones to the headphone jack disconnects the headphone jack contact pin from V_{O1} and allows R_4 to pull the HP Sense pin up to V_{CC} . This enables the headphone function, turns off Amp2, and mutes the bridged speaker. The amplifier then drives the headphone whose impedance is in parallel with R_6 . Resistor R_6 has negligible effect on output drive capability since the typical impedance of headphones is 32Ω . The output coupling capacitor blocks the amplifier's half supply DC voltage, protecting the headphones.

A microprocessor or a switch can replace the headphone jack contact pin. When a microprocessor or switch applies a voltage greater than 4V to the HP Sense pin, a bridged-connected speaker is muted and Amp1 drives the headphones.

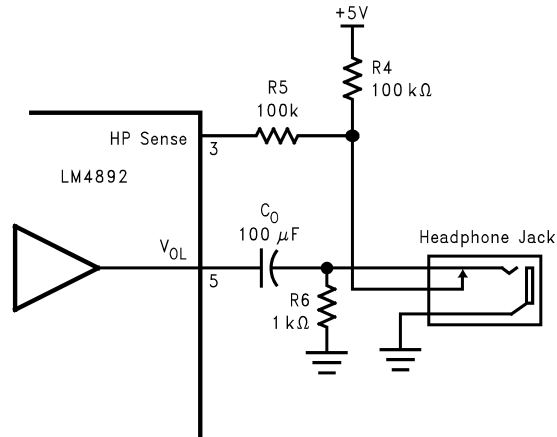

20012774

FIGURE 2. Headphone Circuit (Pin #'s apply to M & MM packages)

PROPER SELECTION OF EXTERNAL COMPONENTS

Proper selection of external components in applications using integrated power amplifiers is critical to optimize device and system performance. While the LM4892 is tolerant of external component combinations, consideration to component values must be used to maximize overall system quality.

The LM4892 is unity-gain stable which gives the designer maximum system flexibility. The LM4892 should be used in low gain configurations to minimize THD+N values, and maximize the signal to noise ratio. Low gain configurations require large input signals to obtain a given output power. Input signals equal to or greater than $1 V_{rms}$ are available from sources such as audio codecs. Please refer to the section, **Audio Power Amplifier Design**, for a more complete explanation of proper gain selection.

Besides gain, one of the major considerations is the closed-loop bandwidth of the amplifier. To a large extent, the bandwidth is dictated by the choice of external components shown in *Figure 1*. The input coupling capacitor, C_i , forms a first order high pass filter which limits low frequency response. This value should be chosen based on needed frequency response for a few distinct reasons.

Selection Of Input Capacitor Size

Large input capacitors are both expensive and space hungry for portable designs. Clearly, a certain sized capacitor is needed to couple in low frequencies without severe attenuation. But in many cases the speakers used in portable systems, whether internal or external, have little ability to reproduce signals below 100Hz to 150Hz. Thus, using a large input capacitor may not increase actual system performance.

In addition to system cost and size, click and pop performance is effected by the size of the input coupling capacitor, C_i . A larger input coupling capacitor requires more charge to reach its quiescent DC voltage (nominally $1/2 V_{DD}$). This charge comes from the output via the feedback and is apt to

Application Information (Continued)

create pops upon device enable. Thus, by minimizing the capacitor size based on necessary low frequency response, turn-on pops can be minimized.

Besides minimizing the input capacitor size, careful consideration should be paid to the bypass capacitor value. Bypass capacitor, C_B , is the most critical component to minimize turn-on pops since it determines how fast the LM4892 turns on. The slower the LM4892's outputs ramp to their quiescent DC voltage (nominally $1/2 V_{DD}$), the smaller the turn-on pop. Choosing C_B equal to $1.0\mu\text{F}$ along with a small value of C_i (in the range of $0.1\mu\text{F}$ to $0.39\mu\text{F}$), should produce a virtually clickless and popless shutdown function. While the device will function properly, (no oscillations or motorboating), with C_B equal to $0.1\mu\text{F}$, the device will be much more susceptible to turn-on clicks and pops. Thus, a value of C_B equal to $1.0\mu\text{F}$ is recommended in all but the most cost sensitive designs.

AUDIO POWER AMPLIFIER DESIGN

A 1W/8Ω AUDIO AMPLIFIER

Given:

Power Output	1 Wrms
Load Impedance	8Ω
Input Level	1 Vrms
Input Impedance	20 kΩ
Bandwidth	100 Hz–20 kHz ± 0.25 dB

A designer must first determine the minimum supply rail to obtain the specified output power. By extrapolating from the Output Power vs Supply Voltage graphs in the **Typical Performance Characteristics** section, the supply rail can be easily found. A second way to determine the minimum supply rail is to calculate the required V_{opeak} using Equation 2 and add the output voltage. Using this method, the minimum supply voltage would be $(V_{\text{opeak}} + (V_{\text{ODTOP}} + V_{\text{ODBOT}}))$, where V_{ODBOT} and V_{ODTOP} are extrapolated from the Dropout Voltage vs Supply Voltage curve in the **Typical Performance Characteristics** section.

$$V_{\text{opeak}} = \sqrt{(2R_L P_O)} \quad (2)$$

5V is a standard voltage in most applications, it is chosen for the supply rail. Extra supply voltage creates headroom that allows the LM4892 to reproduce peaks in excess of 1W without producing audible distortion. At this time, the designer must make sure that the power supply choice along with the output impedance does not violate the conditions explained in the **Power Dissipation** section.

Once the power dissipation equations have been addressed, the required differential gain can be determined from Equation 3.

$$A_{VD} \geq \sqrt{(P_O R_L)} / (V_{IN}) = V_{\text{orms}} / V_{\text{inrms}} \quad (3)$$

$$R_f / R_i = A_{VD} / 2$$

From Equation 3, the minimum A_{VD} is 2.83; use $A_{VD} = 3$.

Since the desired input impedance was $20\text{k}\Omega$, and with a A_{VD} of 3, a ratio of 1.5:1 of R_f to R_i results in an allocation of $R_i = 20\text{k}\Omega$ and $R_f = 30\text{k}\Omega$. The final design step is to address the bandwidth requirements which must be stated as a pair of -3dB frequency points. Five times away from a -3dB point is 0.17dB down from passband response which is better than the required $\pm 0.25\text{dB}$ specified.

$$f_L = 100\text{Hz} / 5 = 20\text{Hz}$$

$$f_H = 20\text{kHz} * 5 = 100\text{kHz}$$

As stated in the **External Components** section, R_i in conjunction with C_i create a highpass filter.

$$C_i \geq 1 / (2\pi * 20\text{ k}\Omega * 20\text{ Hz}) = 0.397\ \mu\text{F}; \text{ use } 0.39\ \mu\text{F}$$

The high frequency pole is determined by the product of the desired frequency pole, f_H , and the differential gain, A_{VD} . With a $A_{VD} = 3$ and $f_H = 100\text{kHz}$, the resulting GBWP = 150kHz which is much smaller than the LM4892 GBWP of 4 MHz. This figure displays that if a designer has a need to design an amplifier with a higher differential gain, the LM4892 can still be used without running into bandwidth limitations.

Application Information (Continued)

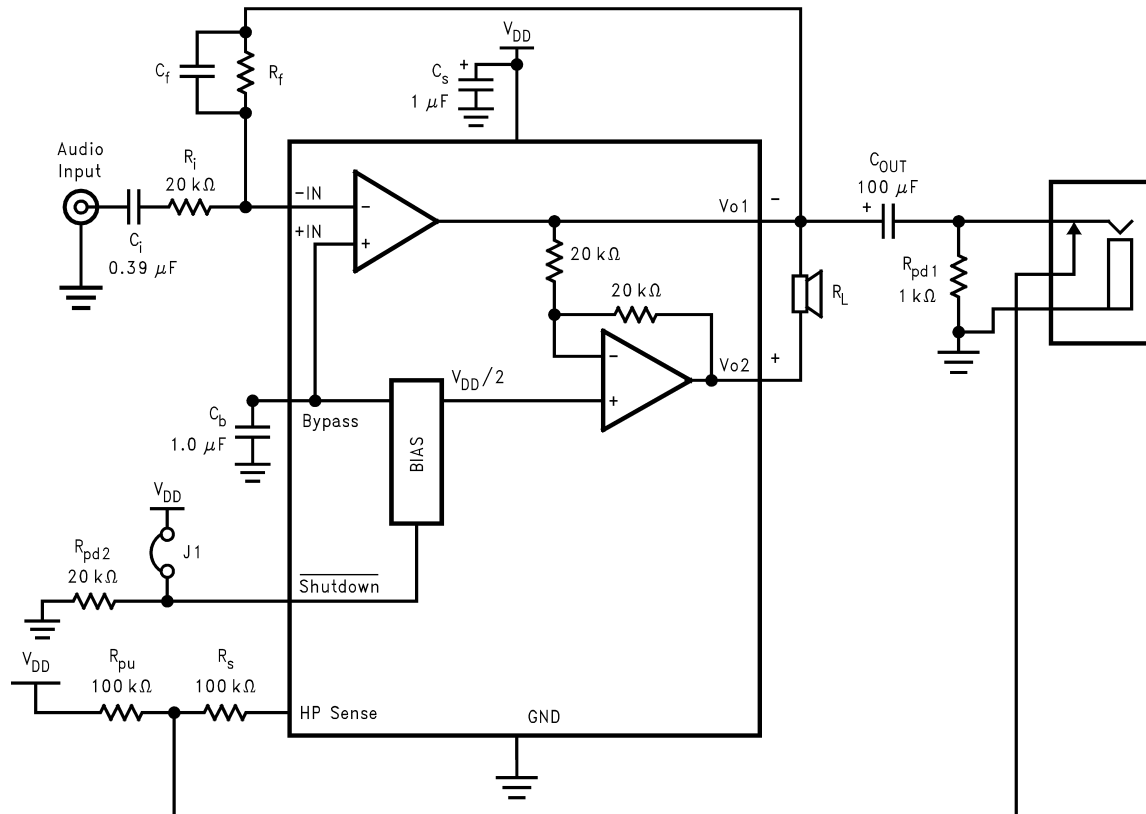

20012724

FIGURE 3. Higher Gain Audio Amplifier

The LM4892 is unity-gain stable and requires no external components besides gain-setting resistors, an input coupling capacitor, and proper supply bypassing in the typical application. However, if a closed-loop differential gain of greater than 10 is required, a feedback capacitor (C_f) may be needed as shown in Figure 3 to bandwidth limit the amplifier. This feedback capacitor creates a low pass filter that elimi-

nates possible high frequency oscillations. Care should be taken when calculating the -3dB frequency in that an incorrect combination of R_f and C_f will cause rolloff before 20kHz. A typical combination of feedback resistor and capacitor that will not produce audio band high frequency rolloff is $R_f = 20\text{k}\Omega$ and $C_f = 25\text{pF}$. These components result in a -3dB point of approximately 320 kHz.

Application Information (Continued)

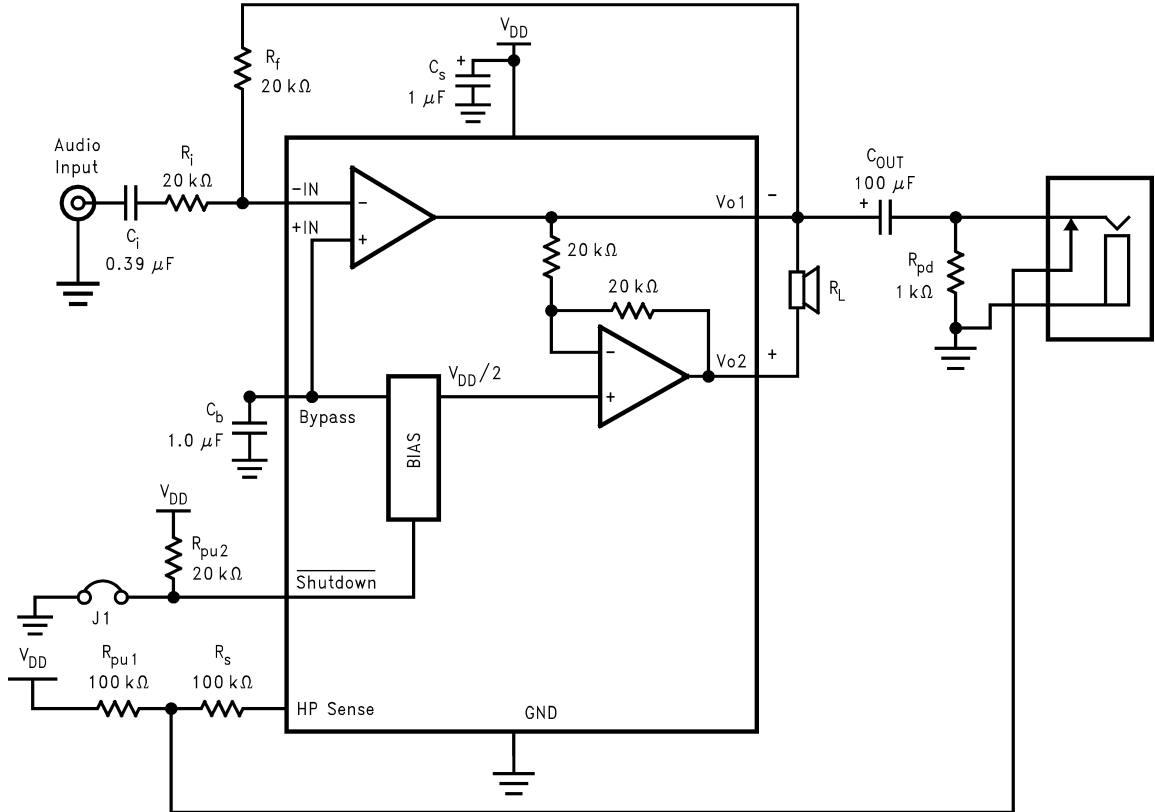

20012775

FIGURE 4. Reference Design Schematic For Demo Boards

Silk Screen

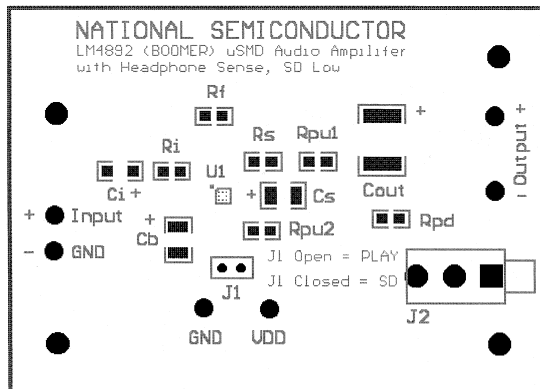

20012757

Top Layer

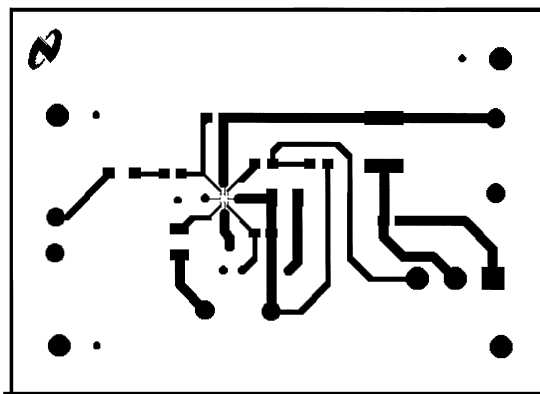

20012758

Bottom Layer

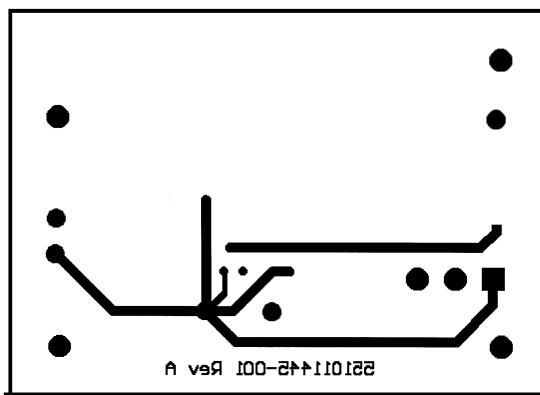

20012759

Application Information (Continued)

LM4892 SO DEMO BOARD ARTWORK

Silk Screen

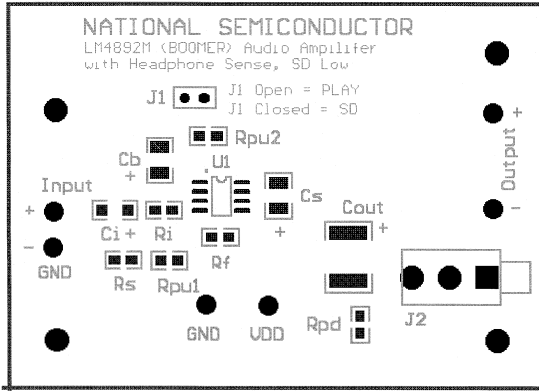

20012762

Top Layer

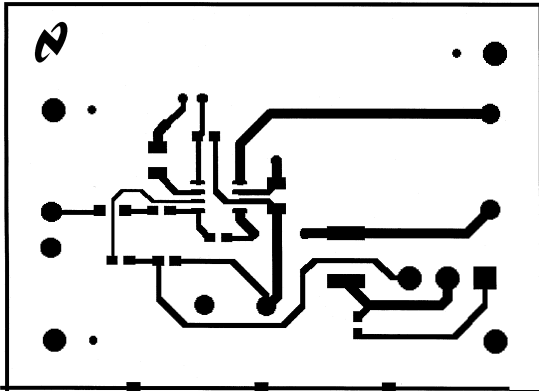

20012763

Bottom Layer

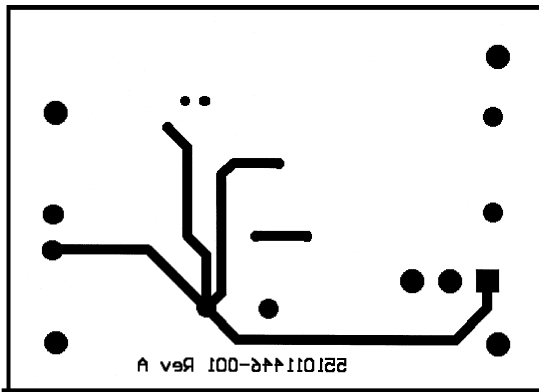

20012764

LM4892 MSOP DEMO BOARD ARTWORK

Silk Screen

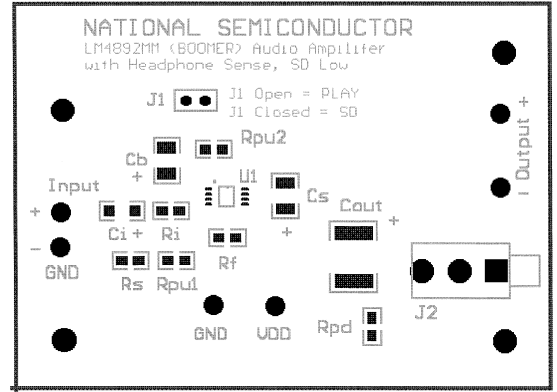

20012765

Top Layer

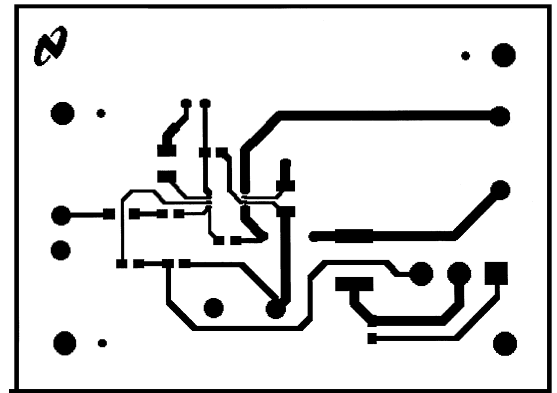

20012766

Bottom Layer

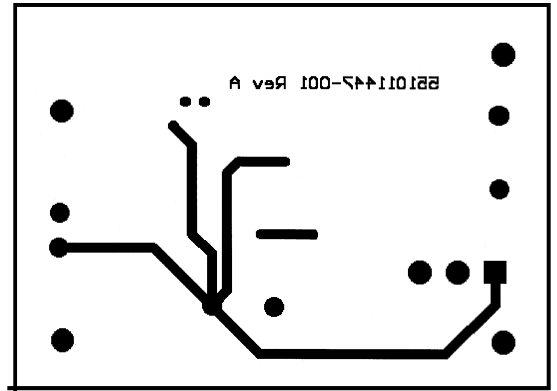

20012767

Application Information (Continued)

LM4892 LLP DEMO BOARD ARTWORK

Composite View

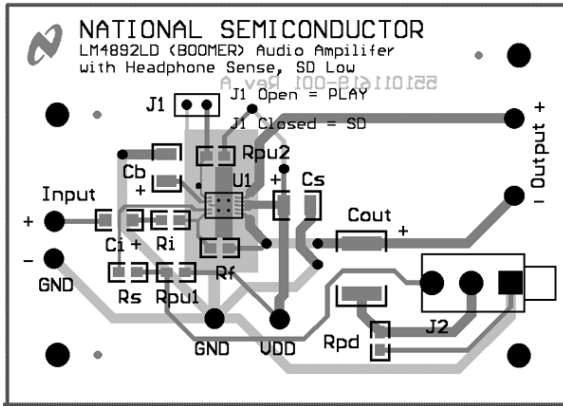

20012790

Silk Screen

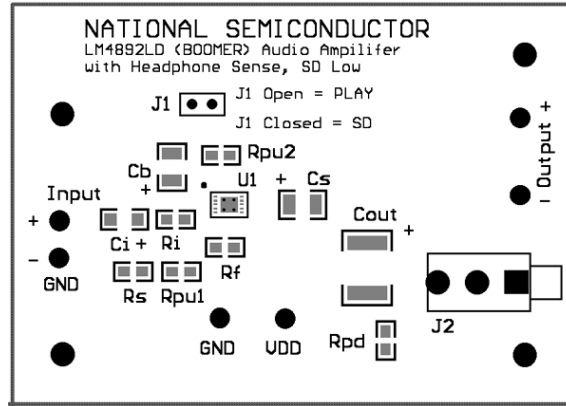

20012791

Top Layer

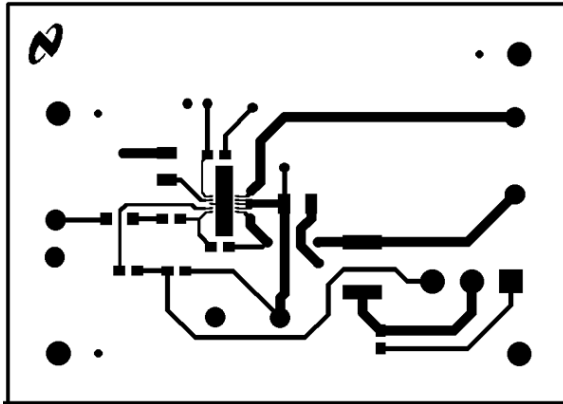

20012792

Bottom Layer

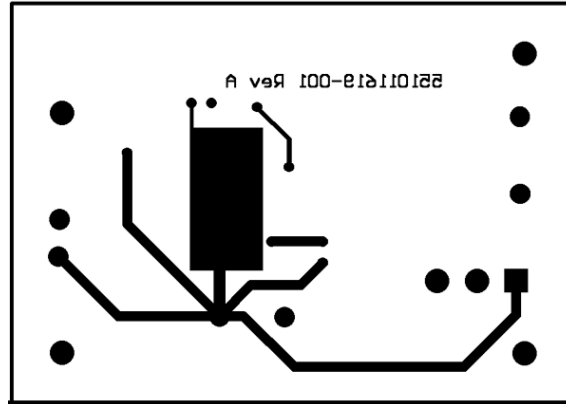

20012793

Application Information (Continued)

Mono LM4892 Reference Design Boards Bill of Material for all Demo Boards

Part Description	Qty	Ref Designator
LM4892 Audio Amplifier	1	U1
Tantalum Capacitor, 1 μ F	2	Cs, Cb
Ceramic Capacitor, 0.39 μ F	1	Ci
Capacitor, 100 μ F	1	Cout
Resistor, 1k Ω , 1/10W	1	Rpd
Resistor, 20k Ω , 1/10W	3	Ri, Rf, Rpu2
Resistor, 100k Ω , 1/10W	2	Rpu1, Rs
Jumper Header Vertical Mount 2X1, 0.100" spacing	1	J1
3.5mm Audio Jack (PC mount, w/o nut), PN# SJS-0357-B Shogyo International Corp. (www.shogyo.com)	1	J2

PCB LAYOUT GUIDELINES

This section provides practical guidelines for mixed signal PCB layout that involves various digital/analog power and ground traces. Designers should note that these are only 'rule-of-thumb' recommendations and the actual results will depend heavily on the final layout.

General Mixed Signal Layout Recommendation

Power and Ground Circuits

For 2 layer mixed signal design, it is important to isolate the digital power and ground trace paths from the analog power and ground trace paths. Star trace routing techniques (bringing individual traces back to a central point rather than daisy chaining traces together in a serial manner) can have a major impact on low level signal performance. Star trace routing refers to using individual traces to feed power and ground to each circuit or even device. This technique will require a greater amount of design time but will not increase the final price of the board. The only extra parts required will be some jumpers.

Single-Point Power / Ground Connections

The analog power traces should be connected to the digital traces through a single point (link). A 'Pi-filter' can be helpful in minimizing High Frequency noise coupling between the analog and digital sections. It is further recommended to put digital and analog power traces over the corresponding digital and analog ground traces to minimize noise coupling.

Placement of Digital and Analog Components

All digital components and high-speed digital signal traces should be located as far away as possible from analog components and circuit traces.

Avoiding Typical Design / Layout Problems

Avoid ground loops or running digital and analog traces parallel to each other (side-by-side) on the same PCB layer. When traces must cross over each other do it at 90 degrees. Running digital and analog traces at 90 degrees to each other from the top to the bottom side as much as possible will minimize capacitive noise coupling and cross talk.

Physical Dimensions inches (millimeters) unless otherwise noted

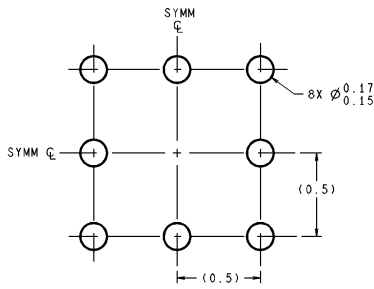

DIMENSIONS ARE IN MILLIMETERS

LAND PATTERN RECOMMENDATION

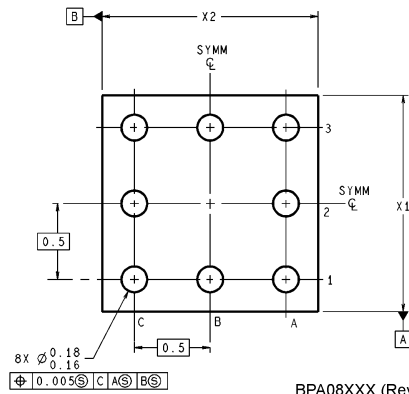
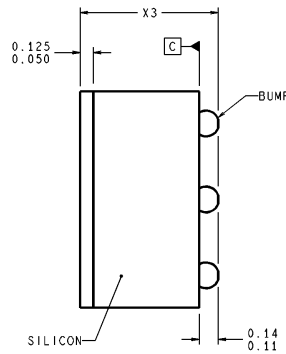
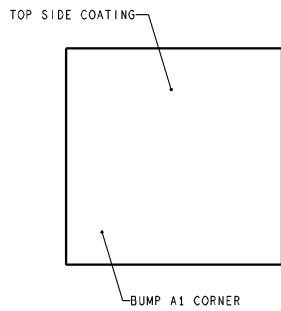

BPA08XXX (Rev C)

Note: Unless otherwise specified.

1. Epoxy coating.
2. 63Sn/37Pb eutectic bump.
3. Recommend non-solder mask defined landing pad.
4. Pin 1 is established by lower left corner with respect to text orientation pins are numbered counterclockwise.
5. Reference JEDEC registration MO-211, variation BC.

8-Bump micro SMD
Order Number LM4892IBP, LM4892IBPX
NS Package Number BPA08DDB
X1 = 1.361±0.03 X2 = 1.361±0.03 X3 = 0.850±0.10

Physical Dimensions inches (millimeters) unless otherwise noted (Continued)

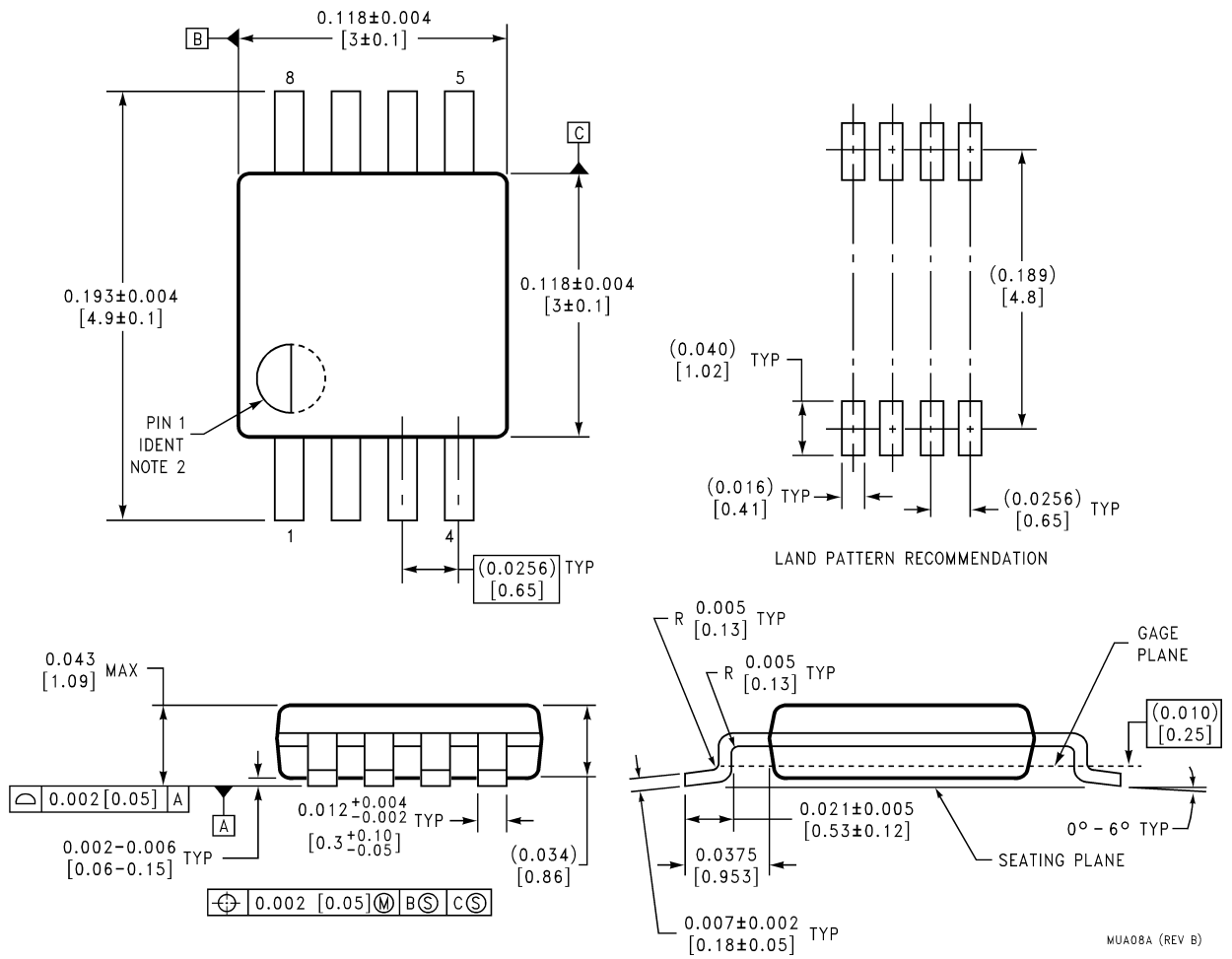

MSOP
Order Number LM4892MM
NS Package Number MUA08A

Physical Dimensions

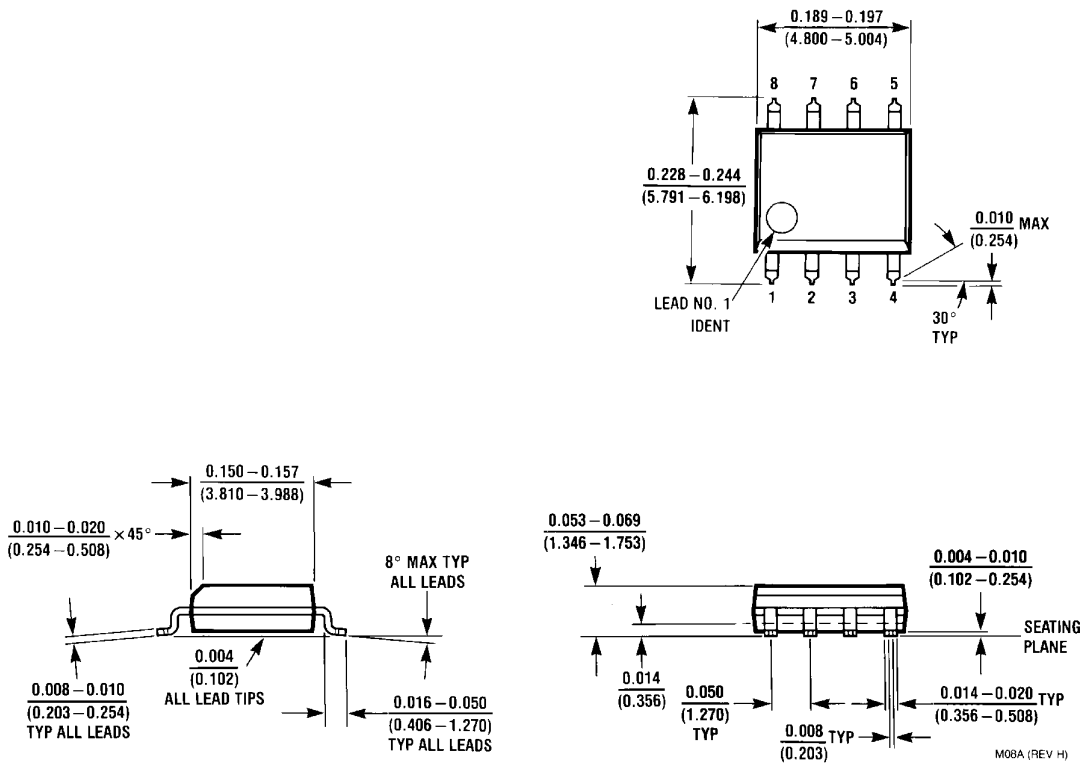
 inches (millimeters) unless otherwise noted (Continued)

SO
Order Number LM4892M
NS Package Number M08A

Physical Dimensions inches (millimeters) unless otherwise noted (Continued)

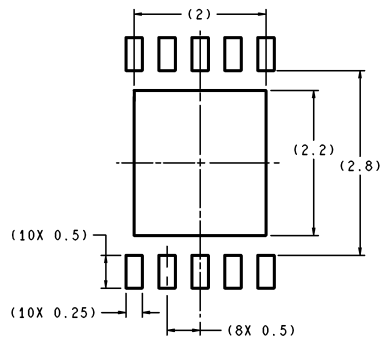

RECOMMENDED LAND PATTERN
1:1 RATIO WITH PKG SOLDER PADS

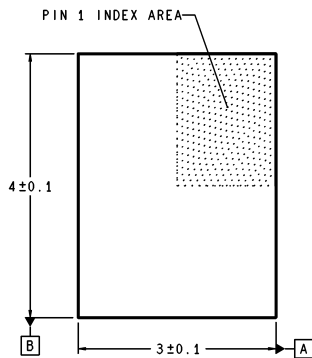

DIMENSIONS ARE IN MILLIMETERS

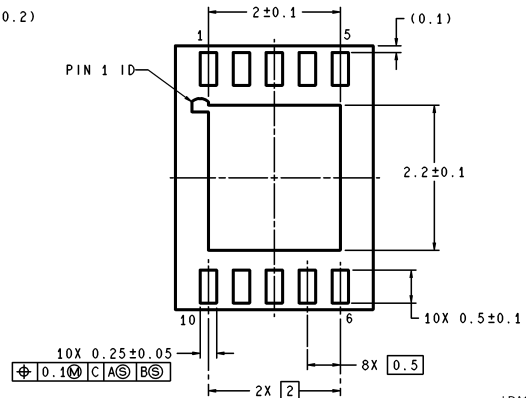
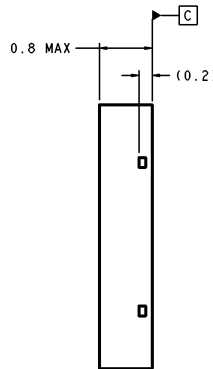

LDA10B (Rev A)

LLP
Order Number LM4892LD
NS Package Number LDA10B

LIFE SUPPORT POLICY

NATIONAL'S PRODUCTS ARE NOT AUTHORIZED FOR USE AS CRITICAL COMPONENTS IN LIFE SUPPORT DEVICES OR SYSTEMS WITHOUT THE EXPRESS WRITTEN APPROVAL OF THE PRESIDENT AND GENERAL COUNSEL OF NATIONAL SEMICONDUCTOR CORPORATION. As used herein:

1. Life support devices or systems are devices or systems which, (a) are intended for surgical implant into the body, or (b) support or sustain life, and whose failure to perform when properly used in accordance with instructions for use provided in the labeling, can be reasonably expected to result in a significant injury to the user.
2. A critical component is any component of a life support device or system whose failure to perform can be reasonably expected to cause the failure of the life support device or system, or to affect its safety or effectiveness.



National Semiconductor
Americas Customer Support Center
Email: new.feedback@nsc.com
Tel: 1-800-272-9959

www.national.com

National Semiconductor
Europe Customer Support Center
Fax: +49 (0) 180-530 85 86
Email: europe.support@nsc.com
Deutsch Tel: +49 (0) 69 9508 6208
English Tel: +44 (0) 870 24 0 2171
Français Tel: +33 (0) 1 41 91 8790

National Semiconductor
Asia Pacific Customer Support Center
Fax: 65-6250 4466
Email: ap.support@nsc.com
Tel: 65-6254 4466

National Semiconductor
Japan Customer Support Center
Fax: 81-3-5639-7507
Email: nsj.crc@jksmtp.nsc.com
Tel: 81-3-5639-7560